

5. Enter your WiFi password.
Connection will now begin.

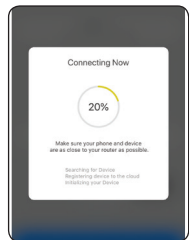

6. Once connected you'll get a menu 'Adding device succeeded'.

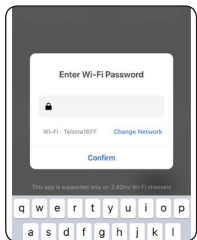
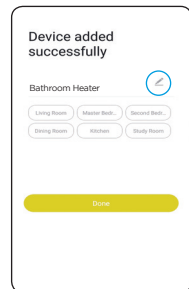

Select the room device and press 'Done'.
You can click on the pen to change the device name. Each switch has preassigned names that cannot be updated.

7. The smart device can now be controlled by the BrilliantSmart app.

Go to www.brilliantsmart.com.au for full instructions and features.

Warranty

Brilliant Lighting warrants this product against defects in manufacture and workmanship for a period of 3 years from date of purchase. Warranty does not include damage or loss arising from incorrect installation, operation or maintenance of this product, damage caused through modification, or incorrect installation.

Our goods come with guarantees that cannot be excluded under the Australian Consumer Law. You are entitled to a replacement or refund for a major failure and compensation for any other reasonably foreseeable loss or damage. You are also entitled to have the goods repaired or replaced if goods fail to be of acceptable quality and the failure does not amount to a major failure.

Any claim under this warranty must be made within 3 years of the date of purchase of the product.

Refer to our website brilliantlighting.com.au for terms and conditions and warranty claims.

This warranty is given by:

Brilliant Lighting (Aust) Pty. Ltd.
ABN 37 006 203 694
956 Stud Road Rowville, VIC 3178
Phone: 03 9765 2555
Email: warranty@brilliantlighting.com.au
MADE IN CHINA

Warning

- To prevent injury, this apparatus must be installed by a Licensed Electrical Contractor.
- For indoor use only.
- Please make sure the smart glass switch is not overloaded. Working power cannot be higher than the rated power (2000W).
- Do not attempt to press touch switch at very high frequencies (faster than one switch per second) as this may result in premature failure.
- If the switch is used to operate appliances intended for supervised use (eg. heater), ensure that the appliance instructions are followed and the appliance is physically supervised whilst on. Do not allow any cables, furnishings, flammable materials or other items to come in contact with any surface of a heater.

Disposal

Please dispose of this packaging material thoughtfully.

Please dispose of this product thoughtfully once it has passed its useful life. When your smart device comes to the end of its life or you choose to update or upgrade it, please do not dispose of it with your normal household waste. Please recycle where facilities exist.

When disposing of this fitting, check with your local authority for suitable options.

Troubleshooting

Problem: Smart device does not switch ON

Possible Cause	Suggested Solution
No Mains Power	Check connections, fuses and switches

Problem: Cannot link smart device with BrilliantSmart app

Possible Cause	Suggested Solution
1. Modem signal weak	Place device and modem closer together
2. Router/modem/smart phone firewall is enabled	Disable firewalls on all devices
3. Internet connection is down	Contact your provider
4. BrilliantSmart app not installed correctly	Remove app and re-install

For any other problems connecting your smart device to BrilliantSmart app please visit:
www.brilliantsmart.com.au/faqs

Brilliant Lighting

956 Stud Road
Rowville Vic 3178 Australia
www.brilliantlighting.com.au
Australian Sales
T 03 9765 2555
T 1800 817 754 (interstate only)
F 03 9763 0277
E sales@brilliantlighting.com.au

New Zealand Sales

T 09 974 9618
E sales@brilliantlighting.com.au



Touch Wall Control
for Ultimo
Bathroom Heater
21017SP054



NO HUB
REQUIRED

WORKS WITH
alexa

Voice
control

Works with
IFTTT

works with the
Google Assistant



INSTRUCTIONAL MANUAL

Box content

Smart Glass Touch Wall Control 4 gang x 1
Instruction Manual x 1

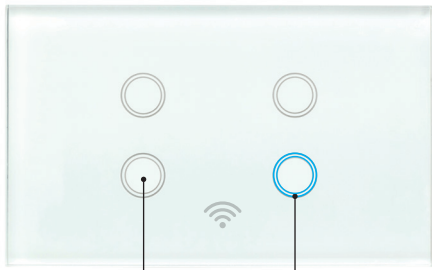

Touch switch

Power indicator buttons - blue when on

Technical Specifications

Model: 21017SP054

Supply voltage: 240V AC 50Hz

Max. load: 4x500W

TA: 0...+35°C

Security: Mac Encryption; WEP/WAPI/TKIP/AES

WiFi Standard: IEEE802.11b/g/n

System Req's: iOS 8.0 or higher, Android 4.1 or higher

1

Installation

THIS FITTING MUST BE INSTALLED BY A QUALIFIED ELECTRICAL CONTRACTOR in accordance with the latest AS/NZS 3000 and relevant amendments

Important Safety Issues

Ensure the power is disconnected before installing. This product is NOT suitable for damp or explosive environments.

Modification of this product will void any warranty. Indoor use only.

Do not cover in insulation.

Product Features

- Three wire design (neutral required).
- Class II Construction.

Installation

The smart glass wall switches are designed to fit standard wall switch cutouts, and plaster/stud brackets with 84mm centres.

Remove the front glass by inserting a flat blade screwdriver into the recess on the side of the switch, twist and remove.

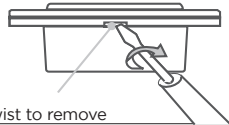

Twist to remove

2

Connect the active incoming supply to L and N using the 20mm² terminals.

Wiring Diagram

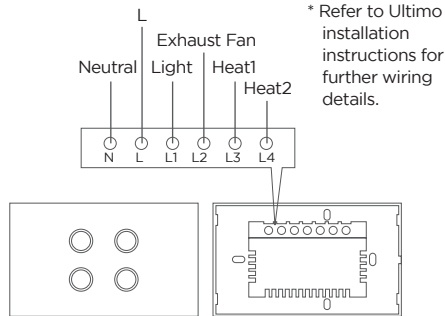

* Refer to Ultimo installation instructions for further wiring details.

Insert the smart glass wall switch onto the wall, aligning the 84mm mounting holes with the plaster/stud bracket holes.

Tighten the mounting screws and replace the cover by clipping on one side followed by the opening side last.

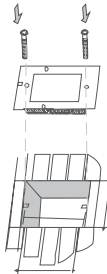

3

Connect to your WiFi

Ensure your mobile phone is connected to your 2.4GHz WiFi network.

Your mobile phone and your smart device needs to be within good signal strength range of your WiFi router. (Refer to your router specifications for max range.)

Download the BrilliantSmart App

Please download the free BrilliantSmart app from the App store or Google Play store, or scan the QR code below.

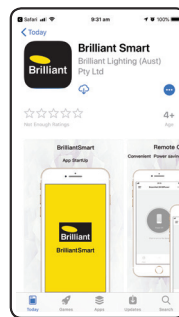

Register the BrilliantSmart App

Open the BrilliantSmart app.

For new users, register a new account or if existing user, login with your user name and password.

4

Configure your BrilliantSmart App

Setting up your Home

You can setup multiple homes or locations. Click 'Add Home' button. Or click on 'Home' top left if you are adding or modifying details then 'Home Management' to setup your home(s), add or rename rooms and share devices.

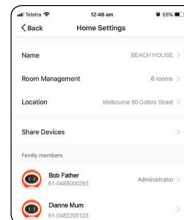

Add your Smart Device to your App

1. Arrange installation of your smart glass touch wall control (and heater) by a Licensed Electrician (refer to installation instructions at start of this manual).
2. Once safely wired, you can pair/connect the device to the app. On initial power-on, the indicator light will begin flashing and be ready to pair (2 times per second). (If the light does not blink, then turn power OFF for 10 seconds. Then power ON again and press and hold any button for 5 seconds. The light will start to blink).
3. Open the BrilliantSmart App, tap 'Add Device' (if empty room) or '+' to add your smart power outlet.
4. Select 'Bathroom Heater' in the list of devices. If the power indicator button(s) are blinking rapidly then press 'Confirm indicator rapidly blink'.

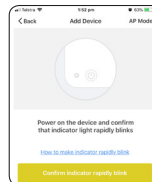

5